

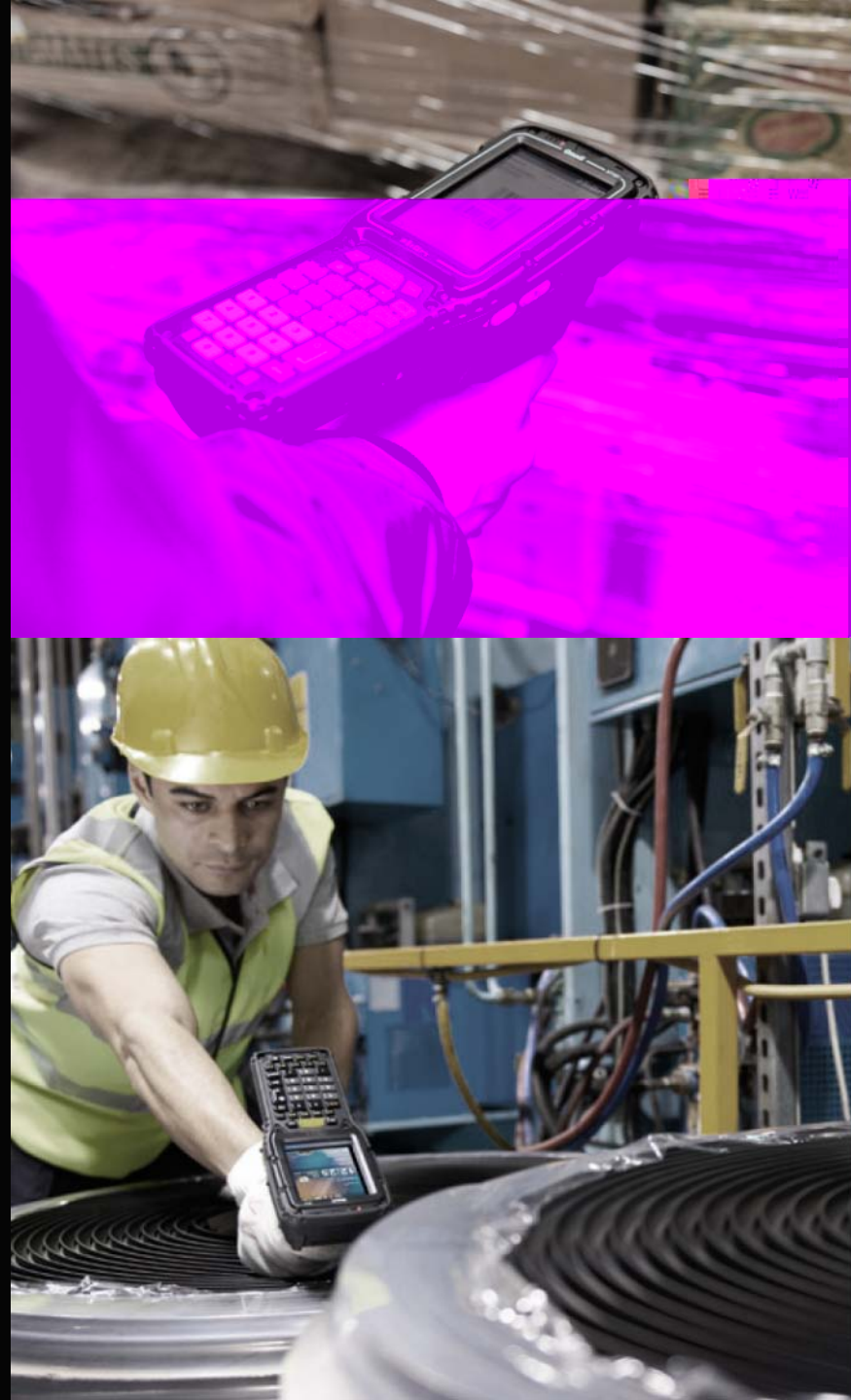

# Omni™ XT15

## EMC Configuration and Accessories Guide

*Designed to assist customers and partners with model and configuration guidance*



## List of changes

### Version Update (March 2016)

1. Slide 3: Added reference *WAP4/XT15 Positioning Strategy Webinar*
2. Slide 8: Updated Exceptions Table
3. Slide 12: Added ST9716 to the Back covers.
4. Slide 16,17,18,19: Added replacement keypad specifics

## Contents

- I. XT15 Series Configuration Guide**
- II. XT15 Series Accessories**



## Main XT15 Variants



## XT15 Variants

### XT15 Standard

#### Operating System

- Windows CE 6.0
- Windows Embedded Handheld 6.5

#### Memory

- 512MB SDRAM/1GB Flash ROM

### XT15ni Non- Incendive

UL Class 1, Div 2,  
Groups A,B,C,D; T6

#### Operating System

- Windows CE 6.0
- Windows Embedded Handheld 6.5

#### Memory

- 512MB SDRAM/1GB Flash ROM

### XT15f Freezer

#### Condensation-Resistant Chiller model

- - 4° F / - 20° C environments

#### Condensation-free Arctic Model

- - 22° F / -30° C freezers

#### Operating System

- Windows CE 6.0
- Windows Embedded Handheld 6.5

#### Memory

- 512MB SDRAM/1GB Flash ROM

### XT15nb Narrowband

#### Operating System

- Windows CE 6.0

#### Region & Memory

- 512MB SDRAM/1GB Flash ROM
- UK countries (512 MB RAM/1 GB Flash)
- Non-UK (512 MB RAM/1 GB Flash)

## XT15 Radio Options



### Built-in Radios

802.11 A/B/G/N, Antenna with Bluetooth 2.0 + EDR, No WAN

802.11 A/B/G/N, Antenna with Bluetooth 2.0 + EDR, **UMTS / HSPA+, GPS**

Applicable only for Upgrades / Reconfiguration



### Expansion Radio Module

**RA3050-GPS** HSPA+ and GPS WAN expansion module

**RA3050 - GPS**  
HSPA+ and GPS WAN  
expansion module



RA3050-GPS requires End-cap with HSPA+ Antenna (ST96xx)

**Installation instructions for Radio Modules:**

<http://www.ingenuityworking.com/knowledge/w/knowledgebases/1525.workabout-pro4-product-manuals.aspx>

## XT15 Display Options



### ST2003

#### XT15 High Visibility display module

Offers superior overall visibility with 165 cd/m<sup>2</sup> brightness

### ST2004

#### XT15 Extreme Duty display module

Extreme -20° C and Impact Resistance  
Offers improved impact resistance (1.25 Joule impact) and improved low temperature performance

### ST2008

#### XT15F Chiller display Module

-20° C Temp Extreme Condensation Resistant and Impact Resistance

### ST2007

#### XT15F Arctic Extreme Duty Heated display module

-30° C Temp Extreme Condensation free and Impact Resistance

# XT15 Back Cover Options

## Standard Expansions

<b>ST9002</b>	Blank Expansion Back cover
<b>ST9714</b>	SE4500 Standard 2D Imager
<b>ST9715</b>	SE4600LR Extended 2D Imager
<b>ST9703</b>	SE1524ER 1D Scanner Auto-Range
<b>ST9701</b>	SE1224HP 1D Scanner Standard-Range
<b>ST9004</b>	Push-to-Talk Speaker
<b>ST9013</b>	Push-to-Talk Speaker with Camera
<b>ST9710</b>	SE965 Standard Range 1D Laser for Freezer Units (XT15f)
<b>ST9711</b>	SE1524ER Lorax Engine for Freezer Units (XT15f)
<b>ST9716</b>	SE4600 LR Extended 2D Imager for Freezer Units (XT15f)

! Scanner Engine Back covers cannot be combined with any Pod or End cap Accessories

! Pods and end-caps compatible with speaker and camera back covers

**ST6104**  
**Replacement Pistol Grip Switch Cover**  
 Normally included with each back cover

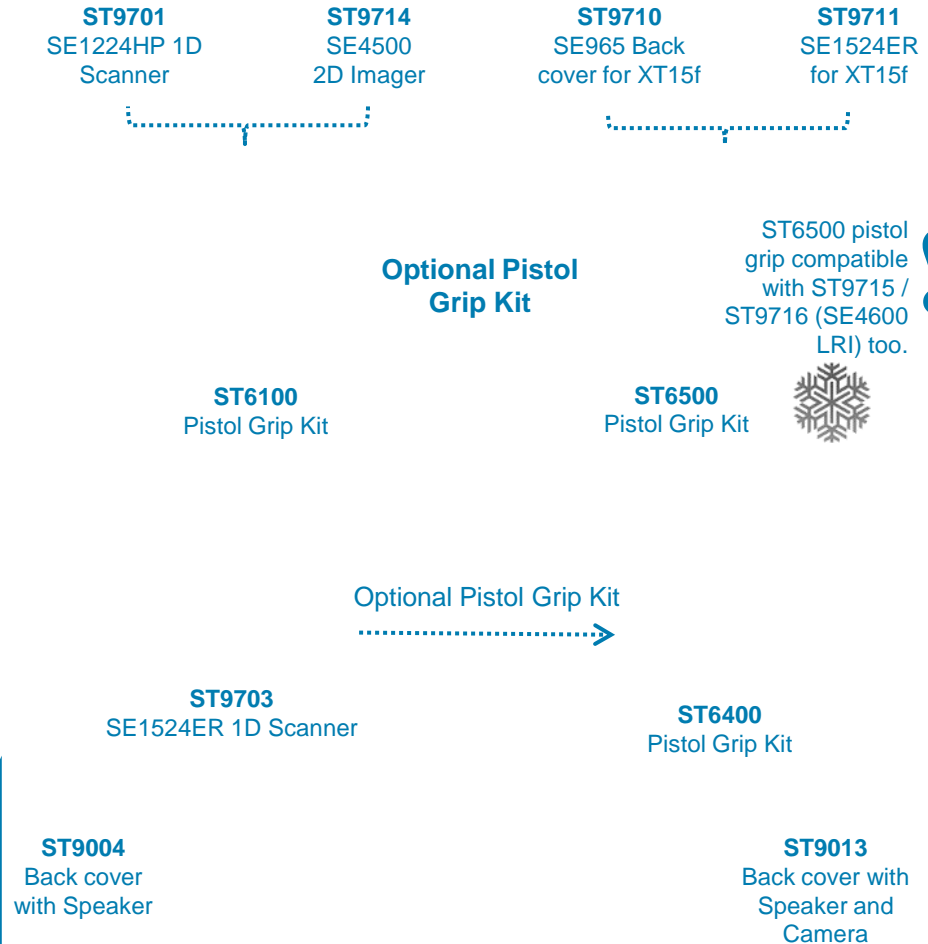

## XT15 Pod Options

### Secondary Expansions

- ST9100** Pod Blanking Cap
- ST9204** SE955 1D Standard Range Scanner (Slim Pod)
- ST9114** SE4500 2D Imager (Standard Pod)
- ST9101** SE1224HP 1D Standard Range Scanner (Standard Pod)
- ST9214** SE4500 2D Imager (Slim Pod)
- ST9210** HF RFID Reader

**ST9114**  
SE4500 2D Imager Standard Pod

**ST9101**  
SE1224HP 1D Scanner Standard Pod

### Optional pistol grip

**ST6000** Pistol grip kit for Standard pod scanners

**ST6000**  
Pistol Grip Kit

**ST9210**  
HF RFID Reader Pod

 Pistol Grip Kit comes with screws. Order stylus and tether separately

ST6000 only compatible with **Standard** Pod modules (ST9114 and ST9101) 

Works with Speaker, Camera, GPS, Endcap-Scanner, WAN radios but not in combination with pistol grip.   
HF module not compatible with freezer, NI, SE4600 or SE1524

## XT15 End Cap Options

### End-Cap Options

#### Standard Blank End Cap

<b>ST9301</b>	No Antenna
<b>ST9401</b>	GPS Antenna
<b>ST9500</b>	GPS and EDGE/Cellular Antennas
<b>ST9600</b>	GPS and HSPA+/Cellular Antennas

#### SE955 1D Standard Laser End Cap

<b>ST9304</b>	No Antenna
<b>ST9404</b>	GPS Antenna
<b>ST9504</b>	GPS and EDGE/Cellular Antennas
<b>ST9604</b>	GPS and HSPA+/Cellular Antennas

#### SE4500 2D Standard Imager End Cap

<b>ST9314</b>	No Antenna
<b>ST9414</b>	GPS Antenna
<b>ST9514</b>	GPS and EDGE/Cellular Antennas
<b>ST9614</b>	GPS and HSPA+/Cellular Antennas

## Optional Pistol Grip

### ST6300

Flush Mount Pistol Grip Kit for  
End Cap Scanners

Pistol Grip Kit comes with  
Stylus (ST6101) and screws



**ST9301**  
Blank End Cap



## XT15 Battery Options

### 5300 mAh Battery

#### **ST3003**

Standard Battery Pack 5300 mAh, for Omnii XT15 Standard model, all configurations

### 5300 mAh Battery



#### **ST3002**

Arctic Freezer Battery Pack 5300 mAh; ships with XT15 Arctic; compatible with all XT15f models

### 5000 mAh Battery

Hazardous Environments

#### **ST3001-NI**

NI Spare Battery Pack 5000 mAH for XT15ni - Non-Incendive models only

ST3001-NI exclusive to XT15NI, failing to comply will void UL rating



## 34 Key Numeric Telephony

## XT15 Keyboard and Keypad Options

### 36 Key Numeric Telephony

**ST5011**

Large Numeric Keys  
12 Function Keys

Replacement keypad part number:

**ST5111**

### 55 Key Alpha Numeric

**ST5004**

Telephone Style Numeric  
Alpha ABC Layout

Replacement keypad part number:

**ST5104**

### 66 Key QWERTY

**ST5003**

Telephone Style Numeric  
Alpha QWERTY Layout

Replacement keypad part number:

**ST5103**

## XT15 Keyboard and Keypad Options

### 59 Key Alpha Numeric

**ST5010**

Telephone Style Numeric Keys  
6 Function Keys

Replacement keypad part number:

**ST5110**

### 59 Key Alpha Num (ORACLE function keys)

**ST5015**

Telephone Style Numeric

Replacement keypad part number:

**ST5115**

### 66 Key QWERTY (ORACLE function keys)

**ST5016**

Alpha QWERTY Layout

Replacement keypad part number:

**ST5116**

## XT15 Keyboard and Keypad Options

### 58 Key Freezer Keypad

**ST5005**

Alpha Numeric Keys  
6 Function Keys

Replacement keypad part number:

**ST5105**



### 34 Key Freezer Keypad

**ST5014**

Telephone Style Numeric  
12 Function Keys

Replacement keypad part number:

**ST5114**



## XT15 Operating Systems

**Microsoft Windows  
Embedded Handheld 6.5  
Classic Edition**



### Operating System Configurations

Microsoft Windows embedded Handheld 6.5  
Professional Edition

Microsoft Windows Embedded Compact 6.0

**Microsoft Windows  
Embedded Compact 6.0**



OS in Local languages available for download on  
Support Central [https://portal.zebra.com/Support/US-EN/Mobile+Networks+RFID+and+BarCode+Scanners/Mobile+Computers/Handheld+Computers/Omnii\\_XT15\\_US-EN](https://portal.zebra.com/Support/US-EN/Mobile+Networks+RFID+and+BarCode+Scanners/Mobile+Computers/Handheld+Computers/Omnii_XT15_US-EN)

## XT15 Charging Methods

### Single Slot Cradle Kit:

**ST4002**  
(Worldwide except Argentina)

USB only – **Includes:** ST1050 power supply and PX3058 USB Cable (connects to Micro-USB/B port for ActiveSync communications)

**ST4002-AR**  
(Argentina only)

USB only – **Includes:** ST1050-AR power supply and PX3058 USB Cable.

**ST4003**  
(Worldwide except Argentina)

USB, Serial, Ethernet – **Includes:** ST1050 power supply and PX3058 USB Cable (connects to Micro-USB/B port for ActiveSync communications)

**ST4003-AR**  
(Argentina only)

USB, Serial, Ethernet – **Includes:** ST1050-AR power supply and PX3058 USB Cable.



The single slot cradle can charge a XT15 terminal, charges a spare battery and has USB master and slave connections.

### Additional accessories for single slot cradle



#### **ST1050**

Wall Adapter Power Supply (Worldwide except Argentina)

#### **ST1050-AR**

Wall Adapter Power Supply (Argentina only)



#### **PX3058**

Micro USB Cable

#### **ST4100**

Cradle Ethernet / Serial XMOD Kit - adds Ethernet, Serial port to USB Only Single Slot Cradle (ST4002 or ST4002-AR)

## XT15 Charging Methods



### 4 Slot Ethernet/Charging Cradle:

#### ST4004

Docking station quad Ethernet (power cable sold separately)

Ethernet Daisy Chain Capable



#### AC Line Cords:

- 9008693 for North America
- 9008892 for Europe
- 9008950 for UK

#### PS1055-G1

The four slot cradle includes a power supply (PS1055-G1). Must purchase specific country AC Line Cord.



## Battery Charger



#### ST3006

Six slot spare battery charger to be used with high and ultra high capacity batteries. Includes power supply (PS1056-G1). Must order AC line cord separately.

#### MT2031

Wall mount bracket for 6-slot spare battery charger

# XT15 Charging Methods

## Vehicle cradle:

### ST1000

Un-powered Vehicle cradle – designed to securely mount XT15, does not provide any power or peripheral ports

### ST1002

Powered Vehicle cradle 12v-30v - Charges XT15 and also supports Power, USB, RS232 Serial connections. Cables for Power, USB, RS232 ordered separately



MT3324 MT3325

! When using the vehicle cradle, the universal RAM mount arm is required (Order separately 5" or 8" arm)



! A base or clamp is required as vehicle side attachment (Order separately MT3501, MT3502, MT3505, MT3507, MT3509, MT3510)



CA3000  
Power only



CA3001  
Power + Connector block  
with 2 USB + RS232

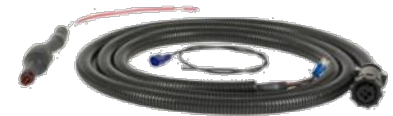

CA1210  
Connects power  
cable to vehicle  
battery

! For powered connection, must order a power cable 9-20V input (CA1210) or the vehicle power outlet adapter cable (CA3000, CA3001)

## Optional Accessories



### CA3002

Vehicle Cradle Cigarette Lighter Adapter



### PS1350

Pre-regulator module required when connecting the vehicle cradle to power sources above 20V to a maximum of 72V.

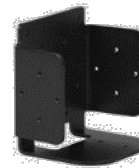

MT3327 has USB RS232  
connector block mount  
capability



MT3328 – RAM  
mount vertical



MT3326 – RAM  
mount horizontal

! A mounting bracket is required when vehicle cradle's RAM mount is anchored to horizontal/vertical surface (Order separately MT3327, MT3326, MT3328)

## XT15 Mobile Charging Options

### Charge only Module



#### **ST4000**

Provides device charging connection

### USB/Charge Module



#### **ST4001**

Provides Micro USB/B, USB/A and charging connections

### RS232/Charge Module



#### **ST4005**

Provides RS232 DE9 and charging connections

All Snap-on modules require ST1050/ST1050-AR Power Supply for AC charging OR ST3113 Cigarette Lighter Adapter for in-vehicle charging

ST4001 also requires PX3058 Micro USB Cable to support ActiveSync connections

#### **ST3113**

Auto Charge/Cigarette Lighter Adapter Cable, 12V DC input

## XT15 Carrying Accessories

### Rubber Boots

**ST6080** Rubber Boot for units with **Standard Back Cover** (Yellow or Grey ST6081)

**ST6086** Rubber Boot (Blue) for **Freezer units with Standard Back Cover** 

**ST6082** Rubber Boot for units with **Expansion Back Cover** (Yellow or Grey ST6083)

**ST6084** Rubber Boot for units with **Expansion Back Cover and End Cap scanner** (Yellow or Grey ST6085)

### Optional shoulder strap for rubber boots

**CV6021** Shoulder strap for use with all rubber boots



**ST6080**  
Rubber boot for units with  
Standard Back Cover

**ST6084**  
Rubber Boot for Units with  
Expansion Back cover and  
End cap scanner



## XT15 Carrying Accessories

### Soft Shell Holsters

Compatible with Pistol Grip units 



#### **ST6050**

Soft shell holster  
Includes waist belt and leg strap

#### **ST6091**

Soft Shell Pouch with Belt Clip



Not compatible with Pistol Grip

### Other Holsters

#### **ST6055**

Hard Shell/Form Fit Holster for units with Standard Back Cover. **ST6056** for units with Expansion Back cover and Std Pods



#### **ST6051**

Forklift  
Holster



#### **ST6052**

Forklift Holster, supports  
Rubber Boot (ST6086)

### Carry Case

#### **ST6090**

Carry Case for units with  
Standard Back cover

#### **ST6092**

Carry Case for units with  
Expansion Back cover

#### **ST6093**

Carry Case for units with  
Expansion Back cover and  
End Cap Scanner – Non FCC  
country approved

Compatible with Pistol Grip units 

## XT15 Carrying Accessories

### Hand Straps

- ST6025** Adjustable double-loop hand strap
- ST6026** Non-adjustable and elastic hand strap (recommended for use with vehicle cradle)

Hand Straps include a storage option for stylus !

### Miscellaneous

- ST6040** Wrist Strap
- ST6101** Short Yellow Stylus (Pack of 3)
- ST6102** Long Grey Stylus (Pack of 3)
- ST6103** Tethers for Stylus (Pack of 3)
- ST6310** Stylus Holder
- RV6105** Screen Protector/Guard

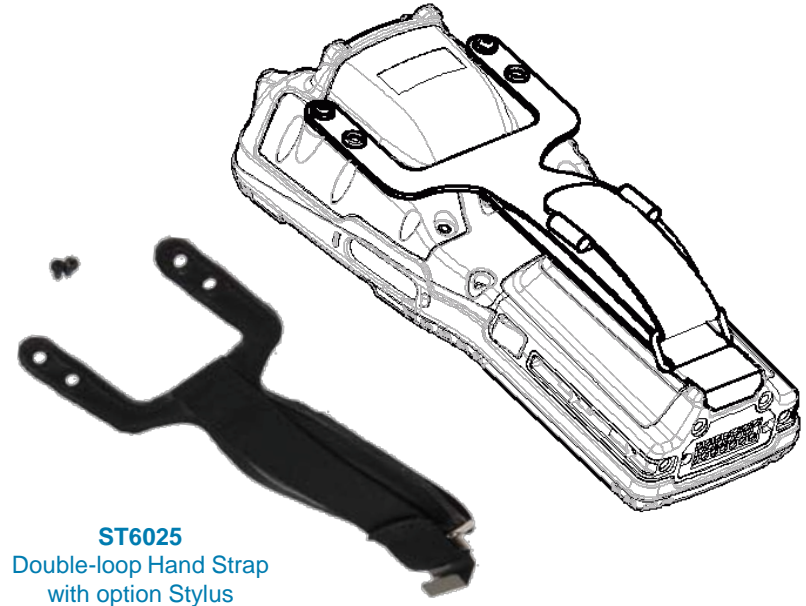

**ST6025**  
Double-loop Hand Strap  
with option Stylus

**ST6310**  
Stylus Holder



**ST6040**  
Wrist Strap